

Varenummer: 207321M81015NI  
Beskrivelse: E+G Pasbolt  
GN 732.1-M8-10-15-NI

## Mål

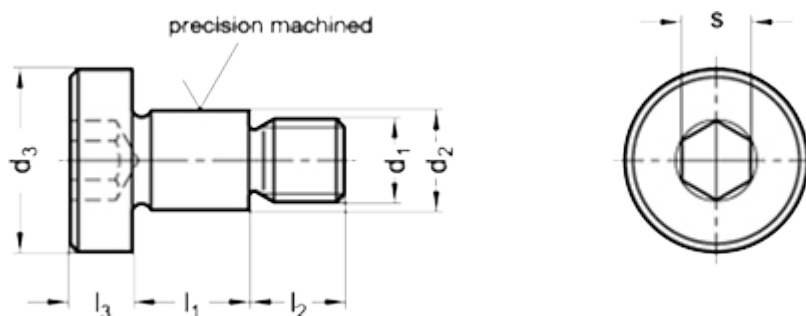

### Application example

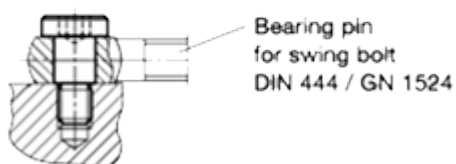

d1	= M 8
d2	= 10 -0.05/-0.08
d3	= 16
$l_1 +0.20/+0.13$	= 15
$l_2$	= 11
$l_3$	= 5
s	= 5
Vægt i (g)	= 18